



floorwise

Uniclass	E485		EPIC
L53611			
C/SFB	(43)	T	
February 2018			

profile portfolio

wiseup@
www.floorwise.co.uk

profiles portfolio

**Providing that finishing touch
for all types of floorcoverings.**

Floorwise profiles are made to the highest standards. Crafted from premium quality metals, our profiles are easy to handle and deliver longer lasting use.

Wrapped in protective film to keep damage and unsightly scratches at bay, Floorwise profiles are packed to arrive in perfect condition.



Max Profile Range: page 3

Where strength and rigidity are a must, make sure it's the Max.

Max Reflections Profile Range: pages 4-5

Give your room the ultimate makeover and co-ordinate with metallic fixtures and fittings using Max Reflections.

Classic Profile Range: pages 6-9

A precision blend of performance and value, the Classic Profile Range includes some of the best selling profiles for carpet and vinyl floorcoverings.

Zenith Profile Range: pages 10-13

Beautifully finished profiles for resilient floorcoverings, the extensive range includes the Stick & Go profiles, speeding up installations saving you time and money.

Flexible PVC Floor Profiles: pages 14-15

A range of quality PVC profiles in a variety of colours that can be laid straight or easily curved on site.

the **max** profile range

max **Reflections** profile range

the **Classic** profile range

the **Zenith** profile range

FlexiblePVC
floor profiles

max profile range

Premium heavy-duty metals mark out the **Max range** to bring complete peace of mind in domestic and commercial applications. Where strength and rigidity are key, **make sure it's the Max** – for profiles that will stand the test of time!

214 Single Edge Raised Base – Super Max Duty



Cat. No. **214A** Polished Aluminium
214S Simbrass

Profile length	2.7m
214A	✓
214S	✓
Tube size: 15 x	
2.7m lengths =	40.5m

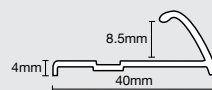

With its highly polished finish, this profile provides a neat attractive edging at doorways and other unprotected edges of carpets that abut vinyl or linoleum. The raised base accommodates thicker underlays.

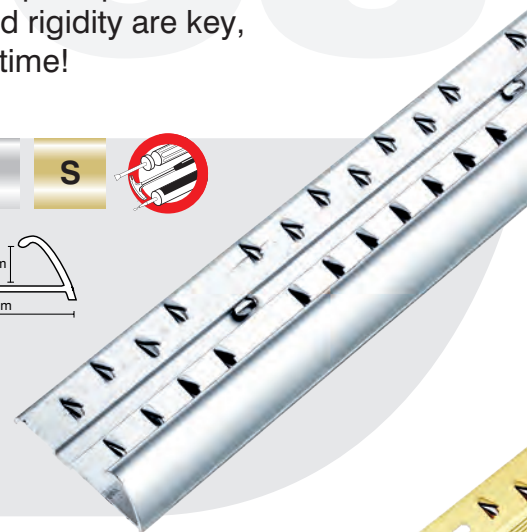

223 Dual Edge – Super Max Duty



Cat. No. **223A** Polished Aluminium
223S Simbrass

Profile length	2.7m
223A	✓
223S	✓
Tube size: 9 x	
2.7m lengths =	24.3m

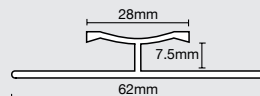

This highly polished profile is a super heavy weight, providing a neat, attractive and very robust join between two carpets.



224 Dual Edge Raised Base – Super Max Duty



Cat. No. **224A** Polished Aluminium
224S Simbrass

Profile length	2.7m
224A	✓
224S	✓
Tube size: 9 x	
2.7m lengths =	24.3m

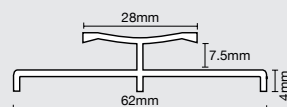

This highly polished profile is a super heavy weight. Similar to 223 but with a raised base to accommodate thicker underlays.



236 Extra Wide Cover Strip 61mm



Cat. No. **236A** Polished Aluminium
236S Simbrass

Profile length	2.7m
236A	✓
236S	✓
Tube size: 15 x	
2.7m lengths =	40.5m



This highly-polished section gives extra coverage and protection to joins between edges on a variety of floor coverings. With an attractive yet practical fluted surface, this profile is drilled, counter-sunk and comes complete with fixing screws.



max Reflections profile range

217 Single Edge (Carpet Edging Strip)

Cat. No.

217C Chrome

217BSN Brushed Steel Nickel

A neat, attractive and robust edging at doorways and other unprotected edges of carpet.

	Profile length	
	0.9m	2.7m
217C	✓	✓
217BSN	✓	✓
Box/Tube size: 13.5m		

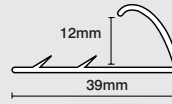

235 Dual Edge (Carpet to Carpet)

Cat. No.

235C Chrome

235BSN Brushed Steel Nickel

A neat, attractive and very robust join between two carpets.

	Profile length	
	0.9m	2.7m
235C	✓	✓
235BSN	✓	✓
Box/Tube size: 13.5m		

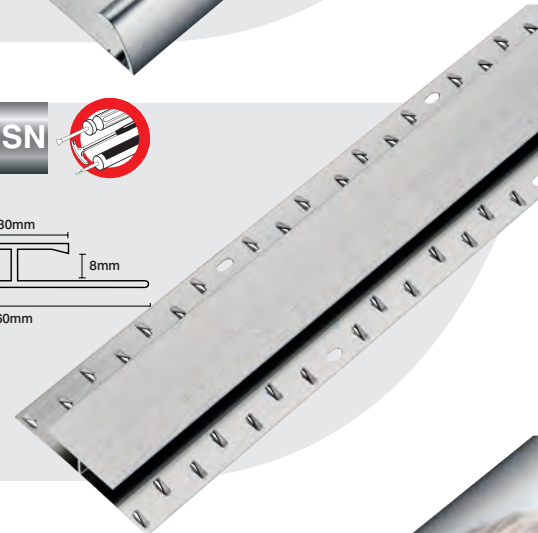
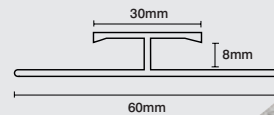

248 Z Edge Adjustable up to 9mm (Carpet to Wood/Laminate/Ceramics)

Cat. No.

248C Chrome

248BSN Brushed Steel Nickel

A versatile and robust profile to join carpet to a variety of floorcoverings. The top can be adjusted to accommodate surfaces of different heights up to 10mm.

	Profile length	
	0.9m	2.7m
248C	✓	✓
248BSN	✓	✓
Box/Tube size: 13.5m		

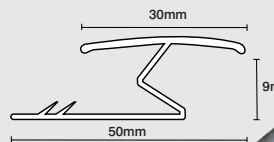

252 Stick Down Cover Strip 38mm (Universal)

Cat. No.

252CA Chrome

252BSNA Brushed Steel Nickel

This versatile cover strip can be used to conceal and protect joints and expansion gaps between all types of wood, laminate and resilient floor coverings.

	Profile length	
	0.9m	2.7m
252CA	✓	✓
252BSNA	✓	✓
Box/Tube size: 13.5m		



Give your room the **ultimate makeover** with **max reflections** from Floorwise. Coordinate with other metallic fixtures and fittings.

Packing

Box: 15 x 0.9m lengths = **13.5m** Tube: 5 x 2.7m lengths = **13.5m**

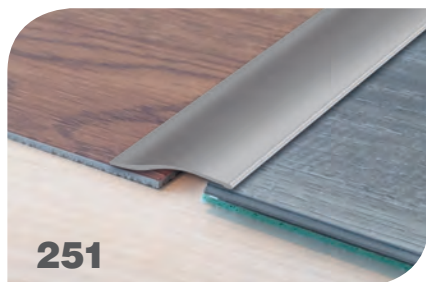
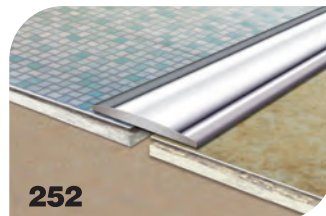
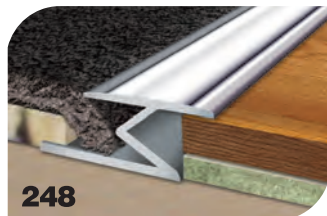
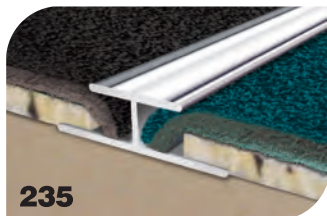
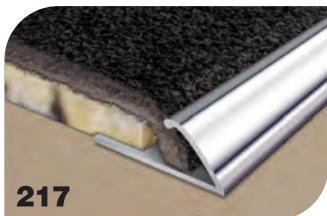
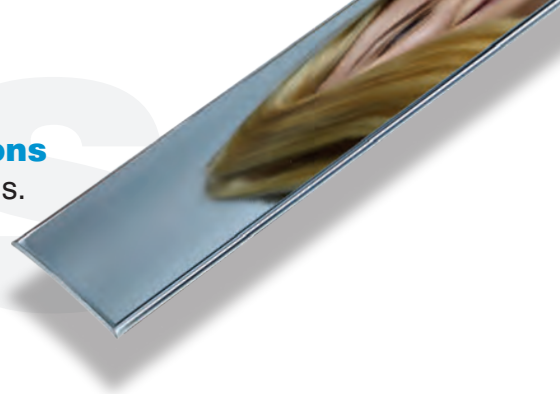

Coordinate with your other **metallic** fixtures + fittings!



251 2-in-1 Stick Down Ramp Edge / Cover Strip 0-6mm



Cat. No.

251CA Chrome

251BSNA Brushed Steel Nickel

This 2-in-1 Stick Down Ramp Edge & Cover Strip is used to conceal and protect joins for wood, laminate, LVT and resilient floorcoverings with a height variation between 0 and 6mm.

	Profile length	
	0.9m	2.7m
251ACA	✓	✓
251BSNA	✓	✓
Box/Tube size: 13.5m		

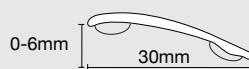

253 2-in-1 Stick Down Ramp Edge / Cover Strip 0-12mm



Cat. No.

253CA Chrome

253BSNA Brushed Steel Nickel

This 2-in-1 Stick Down Ramp Edge & Cover Strip is used to conceal and protect joins for wood, laminate, LVT and resilient floorcoverings with a height variation between 0 and 12mm.

	Profile length	
	0.9m	2.7m
253CA	✓	✓
253BSNA	✓	✓
Box/Tube size: 13.5m		

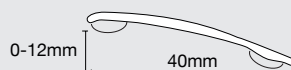

Classic profile range

211 Single Edge

Cat. No. **211A** Polished Aluminium
211S Simbrass

With a highly polished finish, this profile provides a neat, attractive edging at doorways and other unprotected edges of carpets that abut vinyl or linoleum,

	Profile length	
	0.9m	2.7m
211A	✓	✓
211S	✓	✓
Box/Tube size: 40.5m		

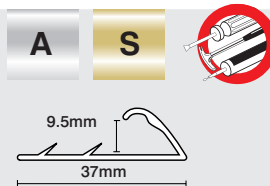

213 Single Edge Unpunched

Cat. No. **213A** Polished Aluminium

The same profile as 211, but unpunched.

	Profile length	
	0.9m	2.7m
213A	✓	
Tube size: 40.5m		

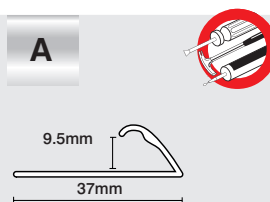

220 Dual Edge

Cat. No. **220A** Polished Aluminium
220S Simbrass

With a highly polished and part fluted surface, this profile provides a neat, attractive and robust join between two carpets

	Profile length	
	0.9m	2.7m
220A	✓	✓
220S	✓	✓
Box/Tube size: 40.5m		

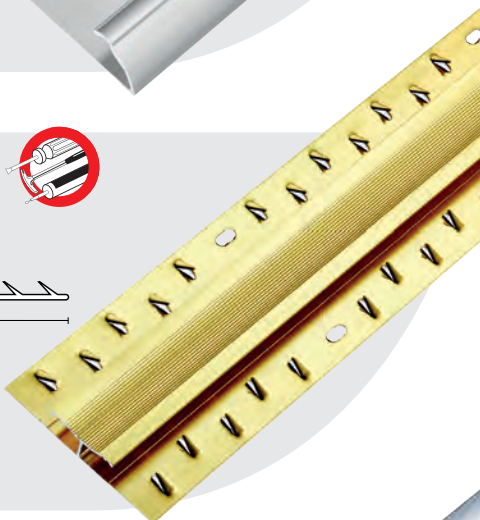
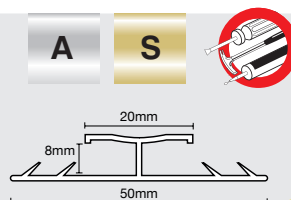

230 Carpet Cover Strip 37mm

Cat. No. **230A** Polished Aluminium
230S Simbrass

With a highly polished and part fluted surface this section conceals and protects the join between carpet edges. Drilled and countersunk it comes complete with fixing screws and is suitable for all types of carpet.

	Profile length	
	0.9m	2.7m
230A	✓	✓
230S	✓	✓
Box/Tube size: 40.5m		

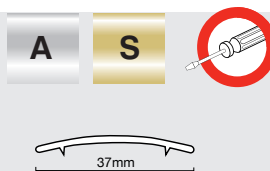

The **Classic Range** is precision-engineered to exacting standards. With more metal for your money, Floorwise premium quality profiles are durable, easier to handle, and finished to perfection.

Packing

Box: 45 x 0.9m lengths = **40.5m** **Tube:** 15 x 2.7m lengths = **40.5m**
 Other lengths may be available upon request.

231 Cover Strip 25mm

Cat. No. **231A** Polished Aluminium

The cover strip conceals and protects joints between all types, and thickness, of resilient floor covering. With a polished surface the section is drilled, countersunk and comes complete with fixing screws.

	Profile length	
	0.9m	2.7m
231A	✓	✓
Box/Tube size: 40.5m		

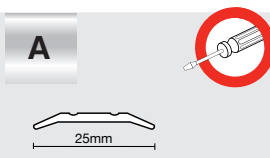

232 Cover Strip 37mm

Cat. No. **232A** Polished Aluminium
232S Simbrass

Similar to 230, this highly polished and part fluted profile conceals and protects the joint between a wide variety of floorcoverings. Drilled and countersunk it comes complete with fixing screws.

	Profile length	
	0.9m	2.7m
232A	✓	✓
232S	✓	✓
Box/Tube size: 40.5m		

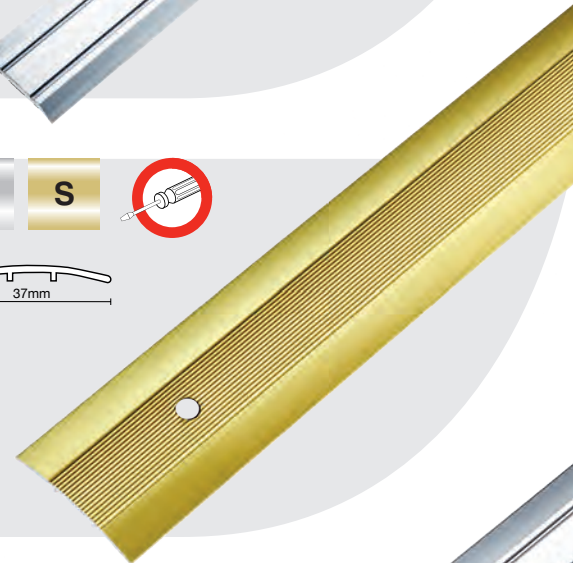
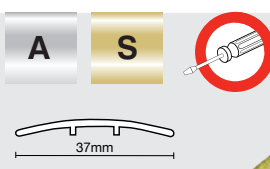

233 Lino Edge Small 4mm

Cat. No. **233A** Polished Aluminium
233S Simbrass

Designed to protect the edges of resilient floor coverings with a thickness of 4mm, the highly polished section is countersunk and comes complete with fixing screws.

	Profile length	
	0.9m	2.7m
233A	✓	✓
233S	✓	✓
Box/Tube size: 40.5m		

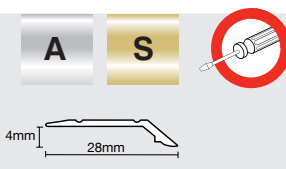

234 Lino Edge Medium 6mm

Cat. No. **234A** Polished Aluminium
234S Simbrass

Similar to 233, but to accommodate grades of resilient floor coverings with a thickness of 5mm. Again these highly polished sections are drilled, countersunk and come complete with screws.

	Profile length	
	0.9m	2.7m
234A	✓	✓
234S	✓	✓
Box/Tube size: 40.5m		

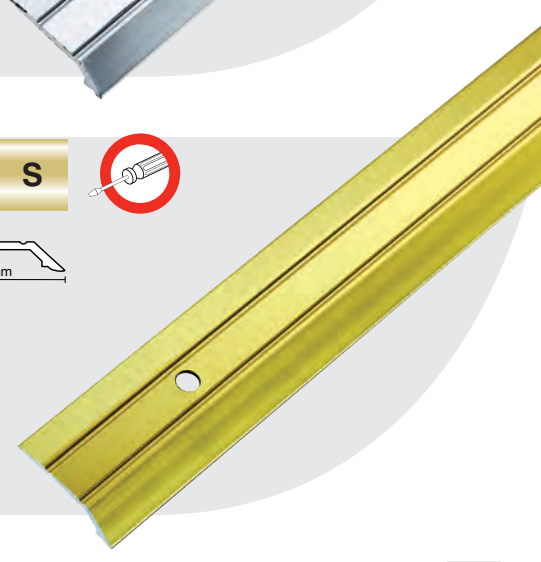
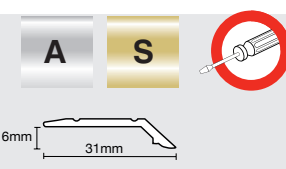

Classic profile range

240 Square Edge Raised Base

Cat. No. **240A** Polished Aluminium
240S Simbrass

A versatile section that can be used as a carpet capping edge, a finish to open plan areas, and edge to access panels and ceramic floors. With its reeded surface, the section will retain its appearance even after heavy wear.

Profile length	2.7m
240A	✓
240S	✓
Tube size:	40.5m

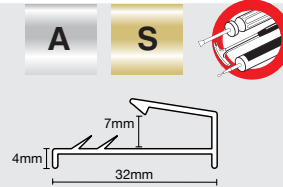

241 Angle / Mat Edge 23mm

Cat. No. **241A** Polished Aluminium

This small angled section is highly polished with a fluting to the upper surface. Suitable for a variety of applications that require a right angled finish. This profile is NOT pre-drilled but can be fitted using one of our Floor-Fix adhesives (F577 or F579).

Profile length	2.7m
241A	✓
Tube size:	40.5m

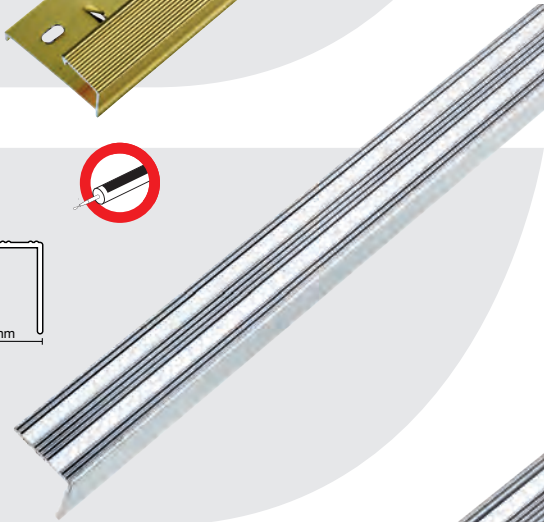
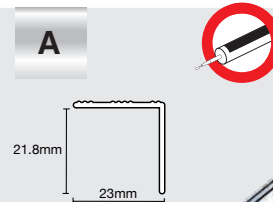

242 Stair / Matwell Edge 42mm

Cat. No. **242A** Polished Aluminium

This reeded profile provides a robust anti-slip edging. It is suitable for stairs, matwells and other installations that require a heavy duty right-angled finish. This item is not pre-drilled but can be fitted using one of our Floor-Fix adhesives (F577 or F579).

Profile length	2.7m
242A	✓
Tube size:	40.5m

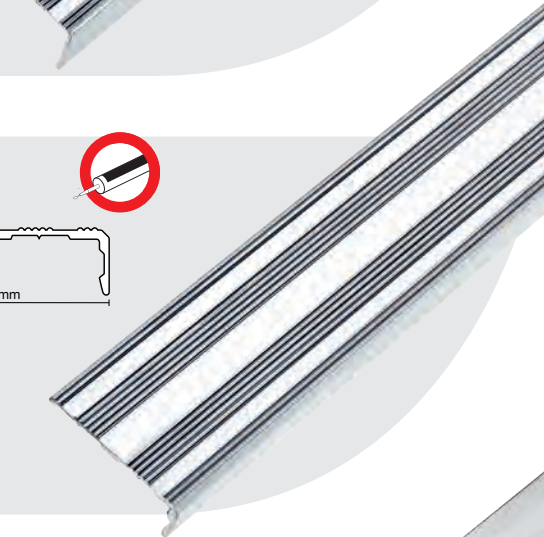
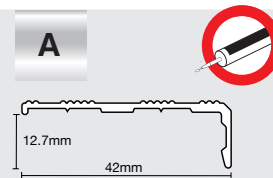

243 Carpet Tile Edge Unpunched

Cat. No. **243A** Polished Aluminium

With a highly polished finish, this profile provides a neat, attractive edging at doorways and other unprotected edges of carpets that abut vinyl or linoleum.

Profile length	2.7m
243A	✓
Tube size:	40.5m

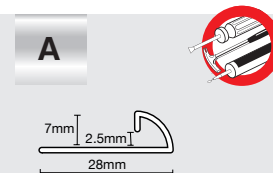

Packing Unless otherwise stated
Box: 45 x 0.9m lengths = **40.5m** **Tube:** 15 x 2.7m lengths = **40.5m**
 Other lengths may be available upon request.

245 Z Edge Adjustable height up to 9mm

Cat. No. **245A** Polished Aluminium
245S Simbrass

This highly polished section is versatile and can be used to join carpets with a variety of floor coverings. The top can be adjusted to accommodate surfaces of different heights up to 9mm.

	Profile length	
	0.9m	2.7m
245A	✓	✓
245S	✓	✓
Box/Tube size: 40.5m		

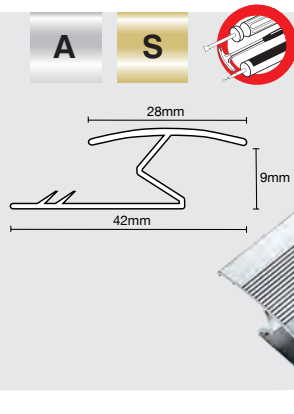

246 Z Edge Adjustable height up to 14mm

Cat. No. **246A** Polished Aluminium
246S Simbrass

This highly polished section is versatile and can be used to join carpets with a variety of floor coverings. The top can be adjusted to accommodate surfaces of different heights up to 15mm.

	Profile length	
	0.9m	2.7m
246A		✓
246S		✓
Tube size: 10 x 2.7m lengths = 27m		

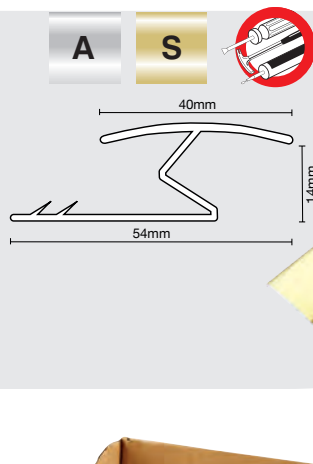

Zenith profile range

251 2 in 1 Stick Down Ramp Edge / Cover Strip 0-6mm

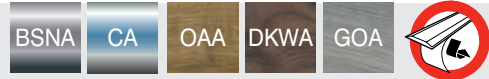

- Cat. No: **251BSNA** Brushed Steel Nickel
251CA Chrome
251OAA Oak
251DKWA Dark Walnut
251GOA Grey Oak

Profile length 2.7m	
251BSNA	✓
251CA	✓
251OAA	✓
251DKWA	✓
251GOA	✓

Tube size: 5 x
2.7m lengths = **13.5m**

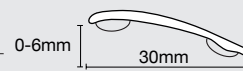

This 2-in-1 Stick Down Ramp Edge & Cover Strip is used to conceal and protect joins for wood, laminate and resilient floorcoverings with a height variation between 0 and 6mm.



253 2 in 1 Stick Down Ramp Edge / Cover Strip 0-12mm

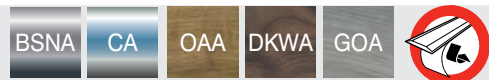

- Cat. No: **253BSNA** Brushed Steel Nickel
253CA Chrome
253OAA Oak
253DKWA Dark Walnut
253GOA Grey Oak

Profile length 2.7m	
253BSNA	✓
253CA	✓
253OAA	✓
253DKWA	✓
253GOA	✓

Tube size: 5 x
2.7m lengths = **13.5m**



This 2-in-1 Stick Down Ramp Edge & Cover Strip is used to conceal and protect joins for wood, laminate, LVT and resilient floorcoverings with a height variation between 0 and 12mm.

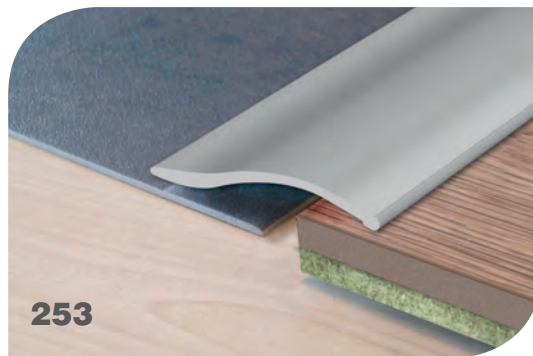
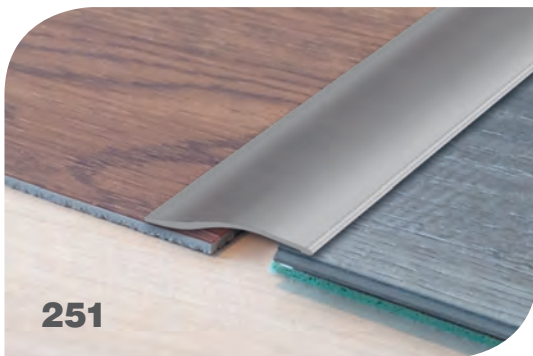

Packing

Tube: 5 x 2.7m lengths = **13.5m** (251 & 253)
 Tube: 10 x 2.7m lengths = **27m** (277 & 287)

Tube: 15 x 2.7m lengths = **40.5m** (245 only)
 Other lengths may be available upon request

A choice of many profiles and finishes in the **Zenith range** makes it easy to find the ideal match to Wood, Laminate & LVT flooring. The range is available in a variety of sizes and heights, which delivers a neat, attractive and robust finish.

The Stick Down range is a must for the professional fitter, cutting down installation time by up to 80% against slower drill and fix methods. Simply cut to size, peel back the tape to reveal the extra strong adhesive and then just **Stick & Go**.

245 Z Edge Adjustable height up to 9mm

Cat. No: **245MG** Matt Gold
245MS Matt Silver

Profile length 2.7m	
245MG	✓
245MS	✓
Tube size: 15 x 2.7m lengths = 40.5m	

This versatile section is used to join carpets with a variety of floor coverings. The top can be adjusted to accommodate surfaces of different heights up to 9mm.

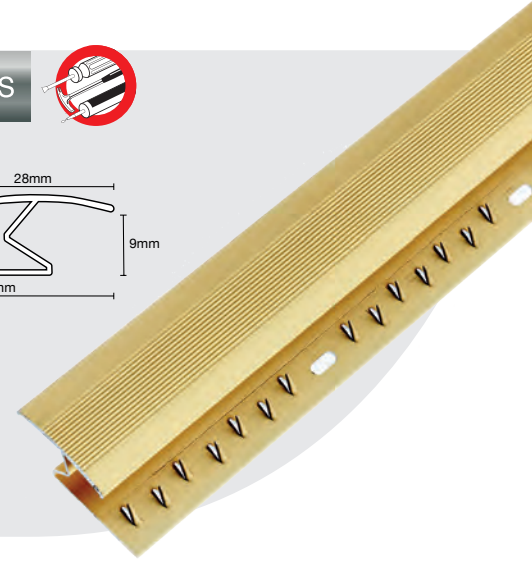
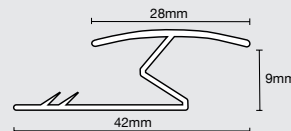

277 Square Edge 8mm

Cat. No: **277MG** Matt Gold
277MS Matt Silver

Profile length 2.7m	
277MG	✓
277MS	✓
Tube size: 10 x 2.7m lengths = 27m	

Ideal as a capping edge, a finish to open plan areas, or edging to access panels and ceramic floors. To accommodate flooring up to 8mm thickness.

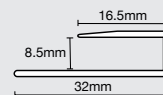

287 Stick Down Edge 9mm

Cat. No: **287MGA** Matt Gold
287MSA Matt Silver
287OAA Oak
287DKWA Dark Walnut
287GOA Grey Oak

Profile length 2.7m	
287MGA	✓
287MSA	✓
287OAA	✓
287DKWA	✓
287GOA	✓
Tube Size: 10 x 2.7m lengths = 27m	

A versatile section which can be used as a capping edge around the room. Also useful around fireplaces and as a finish to open plan areas or as an edge to matwells and access panels.

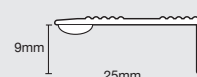
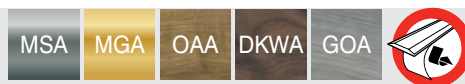

Zenith profile range

288 Stick Down Edge 15mm

Cat. No: **288MGA** Matt Gold
288MSA Matt Silver

A versatile section which can be used as a capping edge around the room. Also useful around fireplaces and as a finish to open plan areas or as an edge to matwells and Access panels. Suitable for use with wood and thicker laminate floors with underlay.

Profile length	2.7m
288MGA	✓
288MSA	✓
Tube Size: 10 x	2.7m lengths = 27m

MGA

MSA

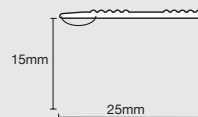

289 Stick Down Sloping Edge 8mm

Cat. No: **289MGA** Matt Gold
289MSA Matt Silver

The Sloping Edge is a transitional profile and protects the edges of floor coverings up to a height of 8mm. With a diminishing sloping edge, the profile provides a ramp down to the adjacent floor covering.

Profile length	2.7m
289MGA	✓
289MSA	✓
Tube Size: 10 x	2.7m lengths = 27m

MGA

MSA

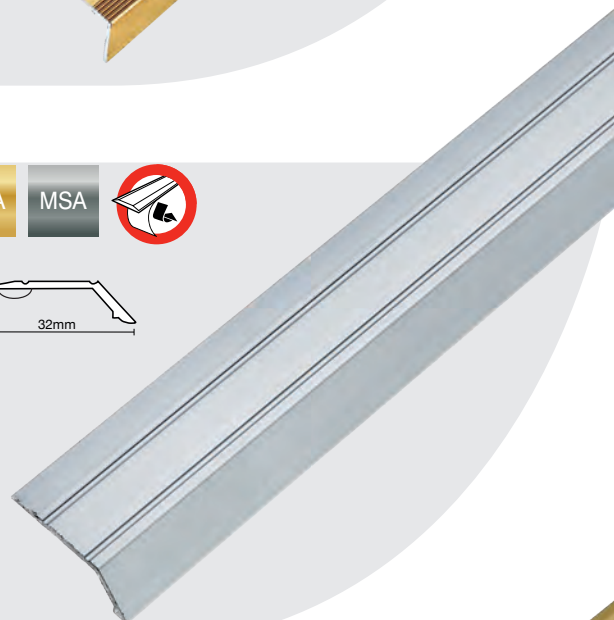
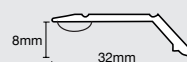

290 Stick Down Sloping Edge 14mm

Cat. No: **290MGA** Matt Gold
290MSA Matt Silver

As **289**, but for use with 14mm wood or laminate on underlay.

Profile length	2.7m
290MGA	✓
290MSA	✓
Tube Size: 10 x	2.7m lengths = 27m

MGA

MSA

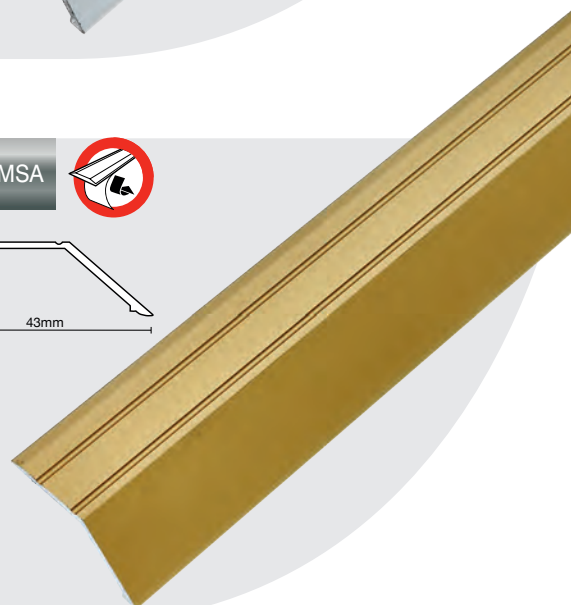
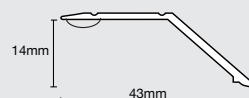

A choice of many profiles and finishes in the **Zenith range** makes it easy to find the ideal match to Wood, Laminate & LVT flooring. The range is available in a variety of sizes and heights, which delivers a neat, attractive and robust finish.

The Stick Down range is a must for the professional fitter, cutting down installation time by up to 80% against slower drill and fix methods. Simply cut to size, peel back the tape to reveal the extra strong adhesive and then just **Stick & Go**.

291 Stick Down Cover Strip 38mm



- Cat. No: **291MGA** Matt Gold
291MSA Matt Silver
291OAA Oak
291DKWA Dark Walnut
291GOA Grey Oak

Profile length	
2.7m	
291MGA	✓
291MSA	✓
291OAA	✓
291DKWA	✓
291GOA	✓
Tube Size: 10 x 2.7m lengths = 27m	



The versatile cover strip can be used to conceal and protect joints and expansion gaps between all types of wood, laminate and resilient floor coverings.



292 Stick Down Sloping Edge 22mm



- Cat. No: **292MSA** Matt Silver

Profile length	
2.7m	
292MSA	✓
Tube Size: 10 x 2.7m lengths = 27m	

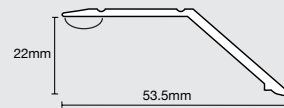

The Sloping Edge is a transitional profile for use with wood flooring or on engineered wood with underlay. With a diminishing sloping edge, the profile provides a ramp down to the adjacent floor covering.



FlexiblePVC floor profiles

8770 Dual Edge

Cat. No. **8770 BLK** Black
8770 CLG Cloud Grey

BLK

CLG



Profile length 2m	
8770	✓
Box size: 25 x 2m lengths = 50m	

Finishing profiles for joints between floorcoverings. Can be easily curved on site.

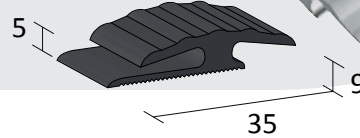

8772 Ramp Edge

Cat. No. **8772 BLK** Black
8772 CLG Cloud Grey

BLK

CLG



Profile length 2m	
8772	✓
Box size: 25 x 2m lengths = 50m	

This flexible profile provides a neat ramp down to the adjacent floor. The profile can be curved to follow the shape of the floor

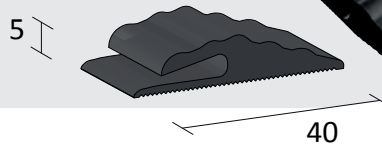

8775 Cover Strip

Cat. No. **8775 BLK** Black
8775 LIG Light Grey
8775 FLI Flint
8775 REG Regency
8775 PEA Peat

BLK

LIG

FLI

REG

PEA



Profile length 2.75m	
8775	✓
Box size: 10 x 2.75m lengths = 27.5m	

Finishing profiles for joints between floorcoverings. Can be easily curved on site.

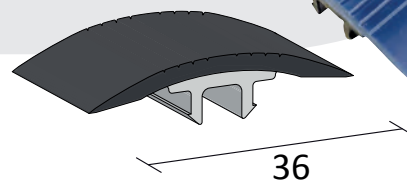

Profiles

A range of **Flexible PVC** transition profiles in a variety of colours that can be laid straight or easily curved on site.

8780 Ramp Edge

- BLK
- LIG
- FLI
- REG
- PEA



- Cat. No. **8780 BLK** Black
8780 LIG Light Grey
8780 FLI Flint
8780 REG Regency
8780 PEA Peat

Profile length	
2.75m	
8780	✓
Box size: 10 x 2.75m lengths = 27.5m	

This flexible profile provides a neat ramp down to the adjacent floor. The profile can be curved to follow the shape of the floor

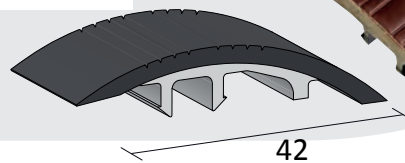

87P1 & 87P2 Base Channel

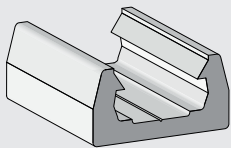

8.5

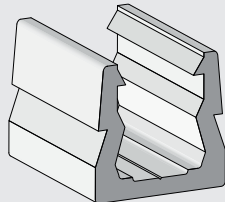

16

Other Base Channels may be available.

Profile length	
2.75m	
87P1	✓
87P2	✓
Box size: 10 x 2.75m lengths = 27.5m	

8775 & 8780 Height Variation Guide

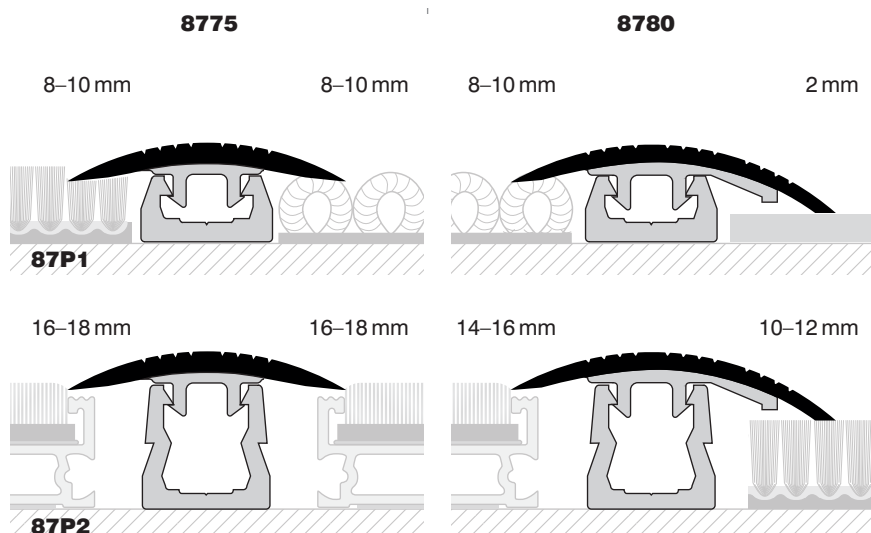

When it comes to flooring installation, **Floorwise** is the name for **quality** and **value**!

For over 35 years Floorwise has been the number one choice for flooring professionals.

Reliable service, through an exclusive network of distributors, and the consistent quality of our products has earned Floorwise an enviable reputation.

Floorwise strives to deliver excellence in innovation too, with a continuous development program aimed at meeting the evolving needs of both consumers and the fitters alike.

for **sales** and **enquiries** contact:

wise up to floorwise quality & value guaranteed



Floorwise offer a wide range of quality foam, rubber and felt underlays, delivering varying levels of performance & suitable for every type of carpet.

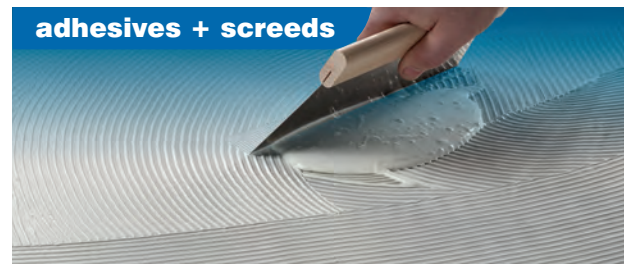

Understanding that reliability is the key, Floorwise Adhesives and have been formulated to bring consistency time after time.



Sourced from the world's best suppliers, the Floorwise Tools collection brings you the very best to make sure your high standards are upheld.

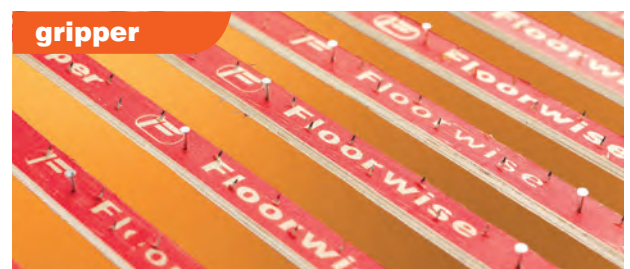

Ensuring a quality installation for each and every carpet, Floorwise Gripper is made to the highest standards.



Floorwise Stair Nosings, PVC Skirting and trims are made to deliver long lasting performance.